

Blackout Instructions

4" R-Series Fascia Installation – Outside Mount

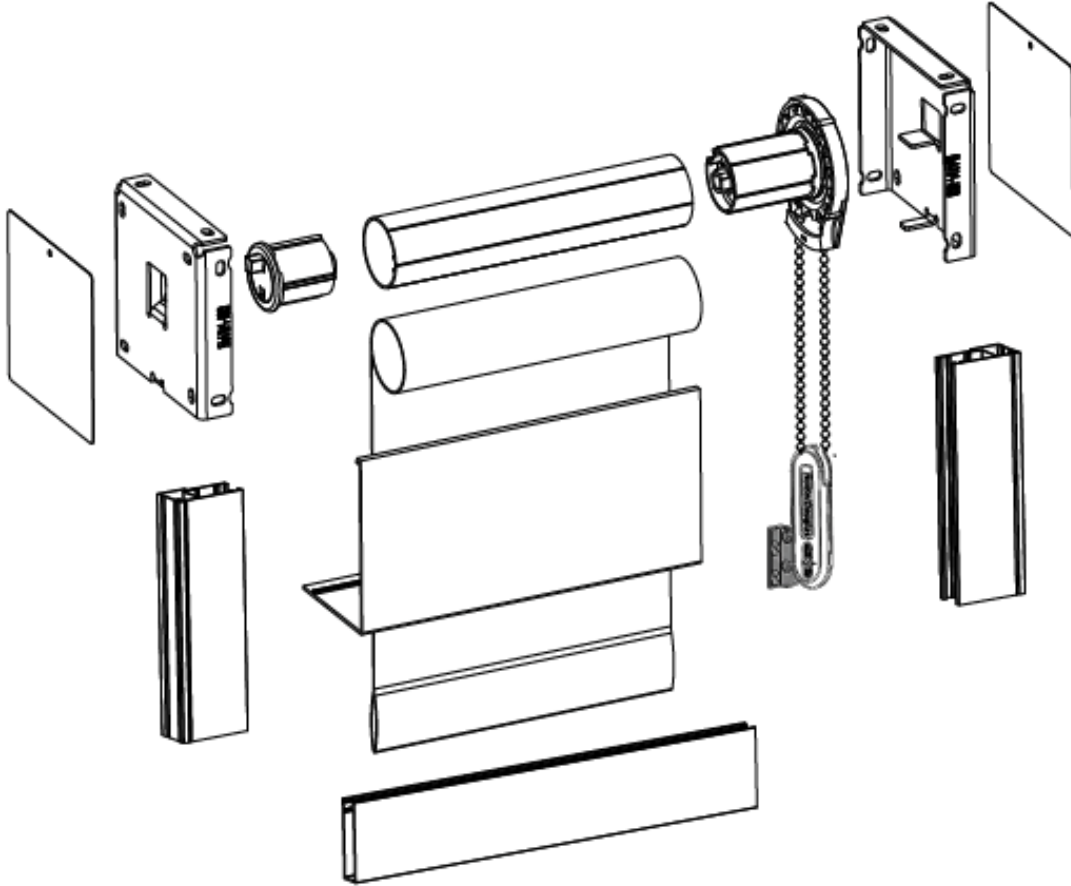

Components Needed _____ *page 3*

Tools Needed _____ *page 4*

System Diagram _____ *page 5*

Instructions

Step 1: Install Brackets. _____ **Page 6**

Step 2: Mount Back Side Channels _____ **Page 6**

Step 3: Install Shade _____ **Page 7**

Step 4: Install Front Side Channels _____ **Page 8**

Step 5: Install Bottom Channel _____ **Page 8**







Step 6: Attach Fascia _____ **Page 9**

Step 7: Install End Plates _____ **Page 10**

Step 8: Install Tension Device _____ **Page 10**

Blackout Instructions

4" R-Series Fascia Installation Instructions

Quantity	Description	Image
1	4" Roller shade assembled to tube with clutch and idler inserted.	
2	4" R-Series Fascia Brackets	
2	End Plates	
1	4" Fascia	
2	Front & Back Side Channels	
1	Bottom Channel	

4" R-Series Fascia Installation

Tools Needed

Screwdriver/Power Drill
1/16" Metal Drill Bit
Screws
Hammer/Mallet
Measuring Tape
Level
Ladder
Chisel
Center Punch
Eye Protection
Gloves

System Diagram

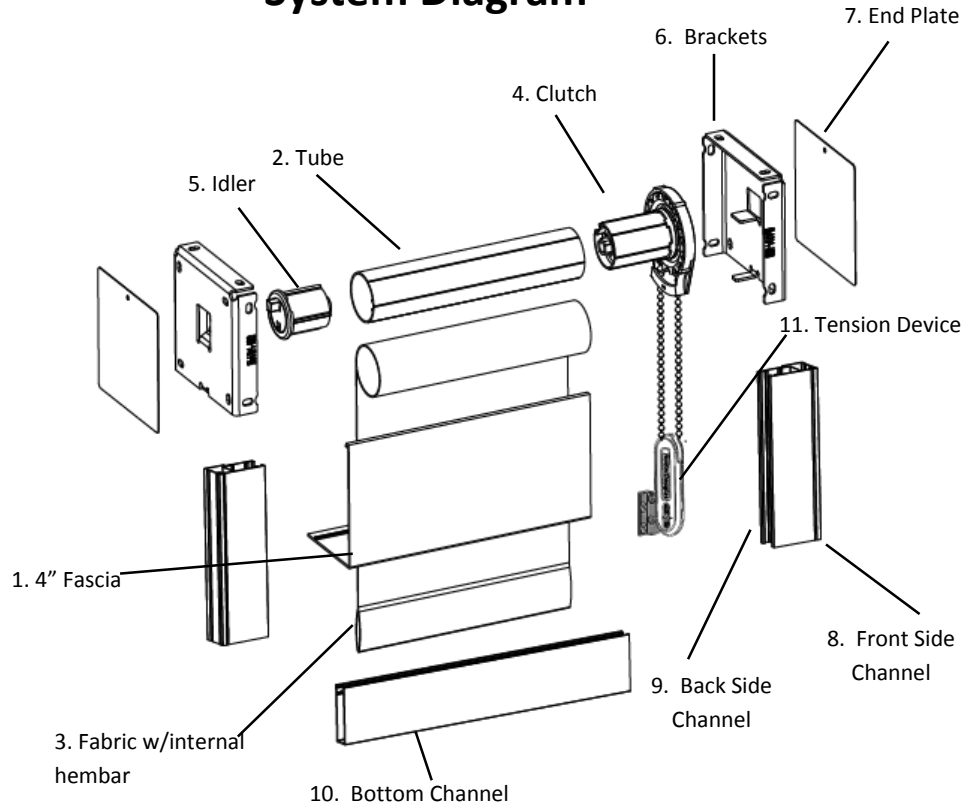

1	4" Fascia
2	Tube
3	Fabric with internal Hembar
4	Clutch
5	Idler
6	4" R-Series Fascia Brackets
7	4" Fascia End Plates
8	Front Side Channel
9	Back Side Channel
10	Bottom Channel
11	Tension Device

Blackout Instructions

4" R-Series Fascia Installation Outside Mount

Step 1: Install Brackets

- 1a. Mount brackets to wall or ceiling in desired location using appropriate mounting screws (ceiling mount)
- 1b. Mount brackets to wall or ceiling in desired location using appropriate mounting screws (wall mount)



Step 2: Mount Back Side Channels (follow steps for right and left back side channels)

- 2a. Decide where to drill holes. Align Back channel under corner of Fascia Bracket so that the side of the back channel is flush with the bracket.
- 2b. Mark mounting screw hole locations with a center punch
- 2c. Pre-drill holes in the back of the side channel using 1/16" metal drill bit
- 2d. Re-align the back channel and mount with the correct mounting screws

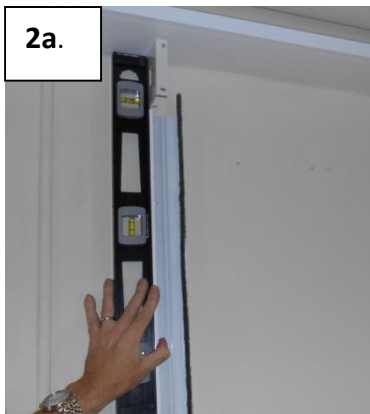

Step 3: Install Shade

4a. Insert Clutch side first by placing the hole in the middle of the core of the clutch into the tab on the middle of the bracket.

4b. Insert Idler by pulling shade up and around the flag on the middle of the idler end bracket (keeping the flag open), then insert the tab on the idler in the bracket (be sure to close flag using lever)

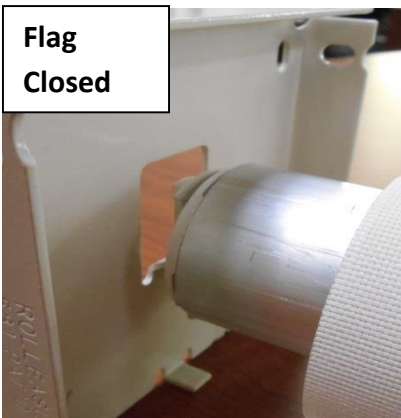
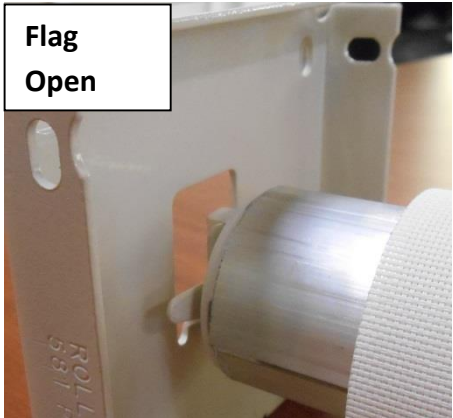
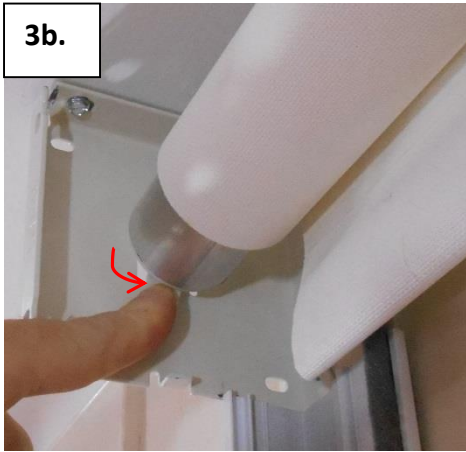
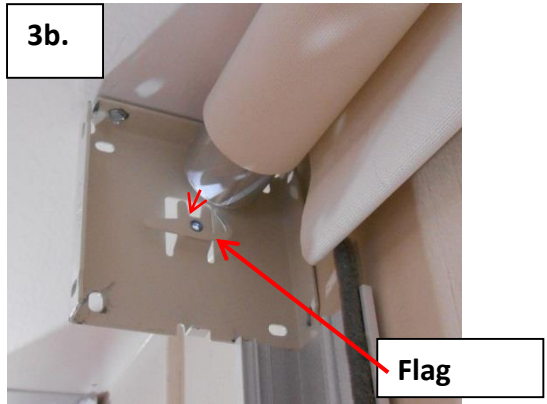

Step 4: Install Front Side Channel

4a. Snap front side channel by engaging lip of front side channel into the groove on the back side channel the snapping closed into place

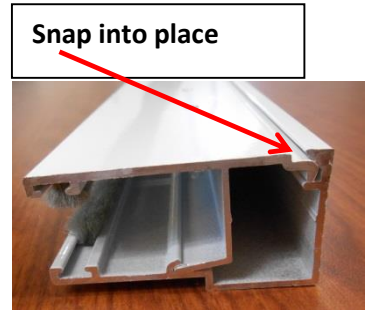
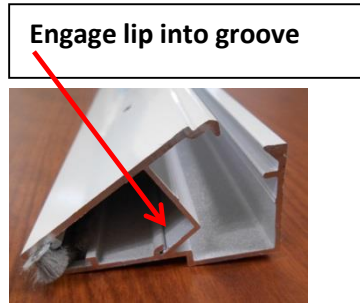

Step 5: Install Bottom Channel

5a. Place left side of bottom channel between the front and back side channels

5b. Slide the right side down in between the front and back side channels until the bottom closure is at the bottom of the side channels

5c. While holding the bottom closure in place, drill a a screw hole using a 1/16" metal drill bit 3/8" from the bottom left hand corner of the side and bottom channel and install mounting screw through both channels.

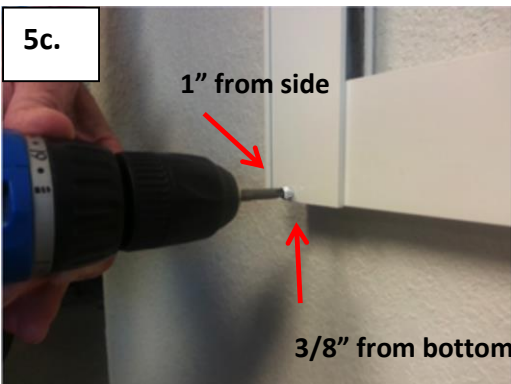
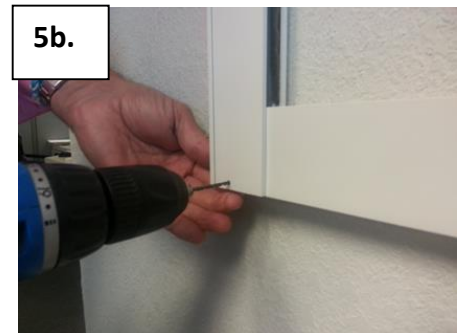

Step 6: Attach Fascia

6a. Engage the groove on the top of the fascia with the corner of the bracket (as shown).

6b. Once it is engaged, lower fascia and push until you feel a click and the groove in the bottom of the fascia clips into the bottom of the bracket.

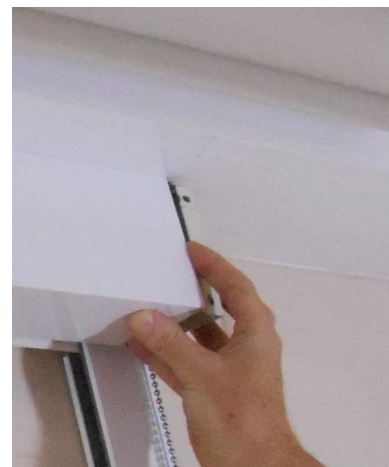
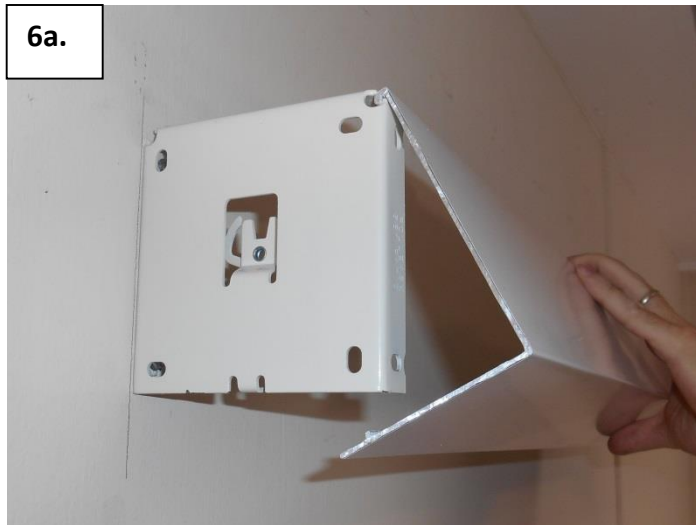

Tip: if you do not have enough clearance to clip the fascia on the top of the bracket, you can slide the fascia over the brackets (if there is enough wall space on the side of the fascia brackets).



Step 7: Install End Plates

7a. Remove paper over the tape on the inside of the end plate

7b. Carefully affix the end cap over the fascia bracket, being sure to cover the edges of the fascia panel

7a.

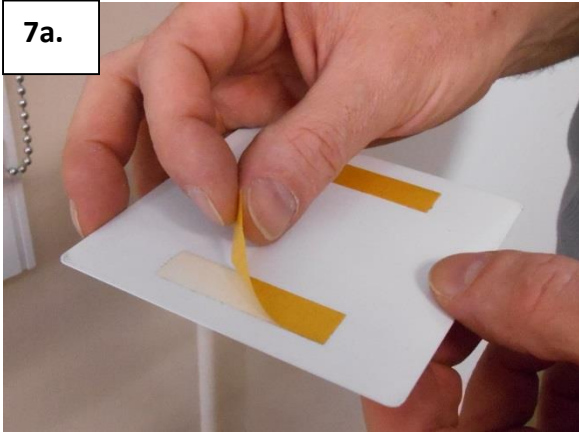

7b.



Step 8: Install Tension Device



