

**Important:** Before starting the programming, install the shade following the installation instructions provided.

**For Honeycomb Shades,** connect the battery cable into the slot located in the endcap, inside the headrail, **before** hanging the shades on the brackets.

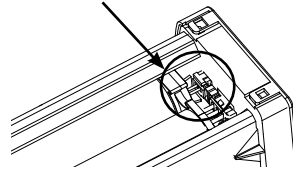

**1a. Attach the Wand — Sheer Shadings, Dual & Roller Shades**

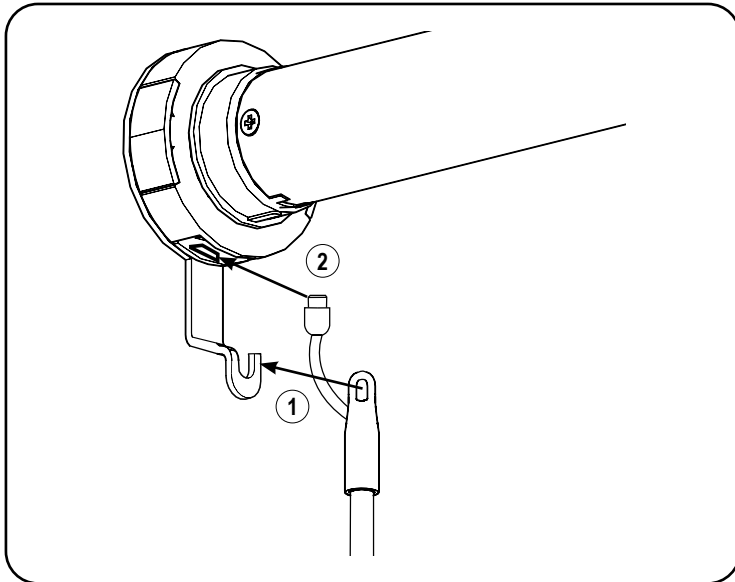

On Dual Shades, Roller Shades and Sheer Shadings, with the wand control buttons facing you, attached the top of the wand on the metal hook support (1) on the motor control side, then connect the cable into the motor head (2).

**1b. Attach the Wand — Honeycomb Shades**

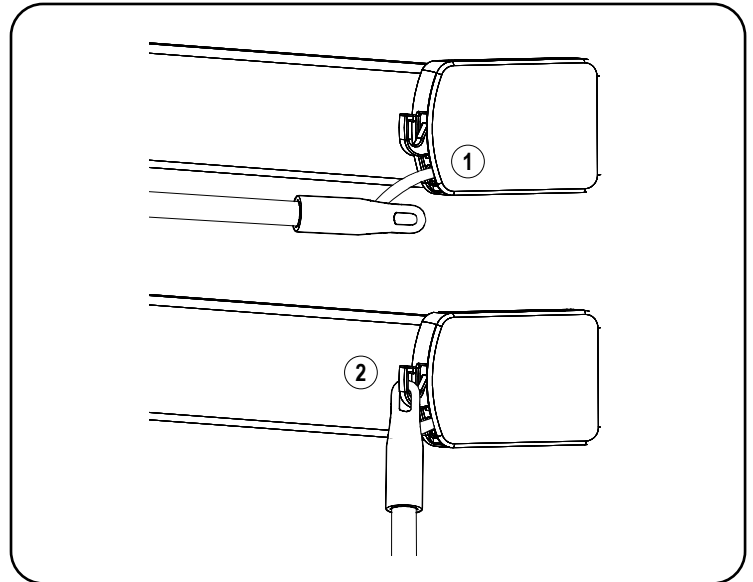

On Honeycomb shades, the wand will be already connected to the shade (1). With the wand control buttons facing you, attached the top of the wand into the plastic hook support on the motor control side (2).

**1c. Attach the Wand — Natural Woven Shades**

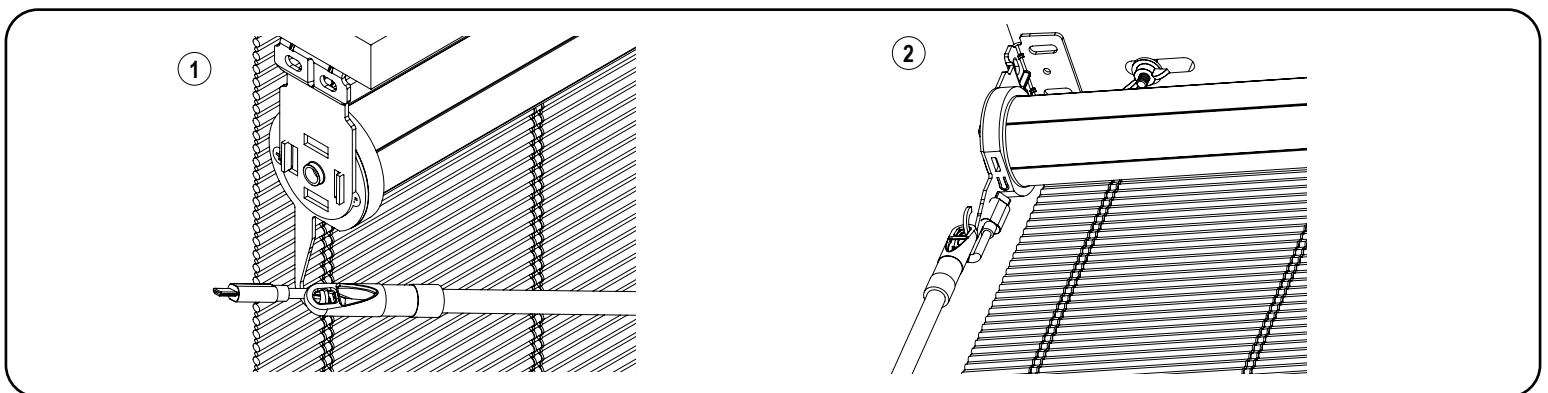

On Natural Woven Shades, with the wand control buttons facing you (1) approach the hook with the wand parallel to the headrail. (2) Gently twist the wand to attach it to the hook. Connect the cable into the motor.

## 2. Operate the Wand

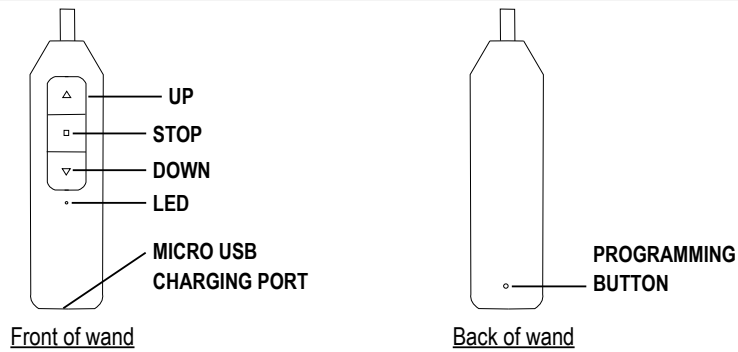

### Roller and Honeycomb Mode:

- Press the **DOWN** or **UP** button to lower or raise the shade. Press the **STOP** to stop the shade at the desired position.

### Window Shadings and Dual Shades Mode:

- Tapping the **UP** or **DOWN** button for less than 2 seconds will move the shade in short steps.
- Holding the **UP** or **DOWN** button down for more than 2 seconds before releasing will operate the shade at the standard speed.
- Press the **STOP** button to stop the shade at the desired position.

## 3. Set a Favorite Position

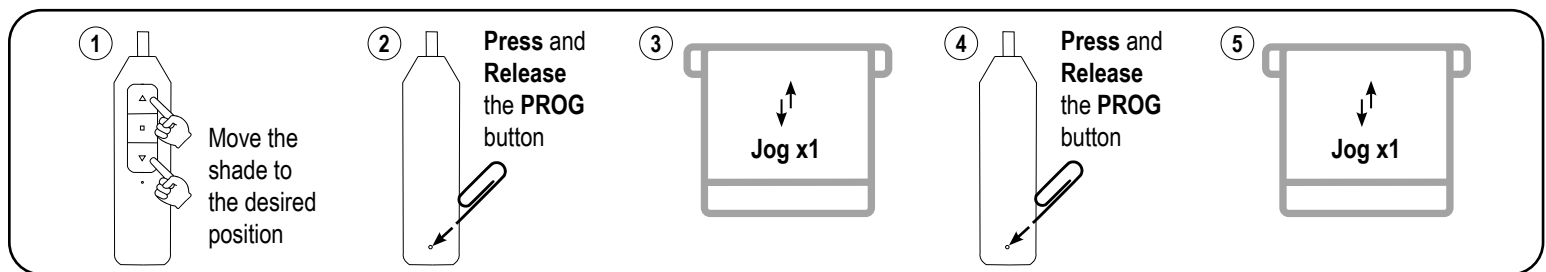

**IMPORTANT:** Once the favorite position is set, the shade will always stop at the designed favorite position when passing by it. Click 2 x Up or Down button, the shade will go to set Top or Bottom Limit.

## 4. Remove a Favorite Position

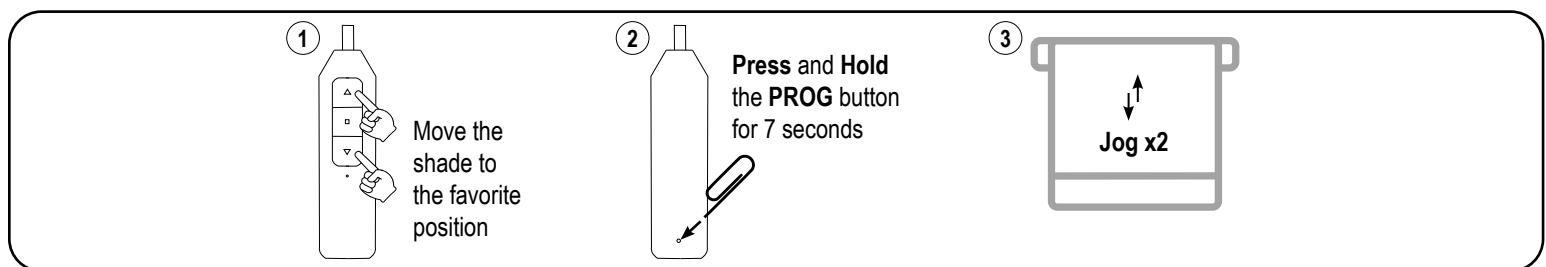

## 5. Advanced Programming

**IMPORTANT:** Damage to shade may occur when operating the motor prior to setting limits. Attention should be given.

### Switch between Roller and Window Shadings Mode

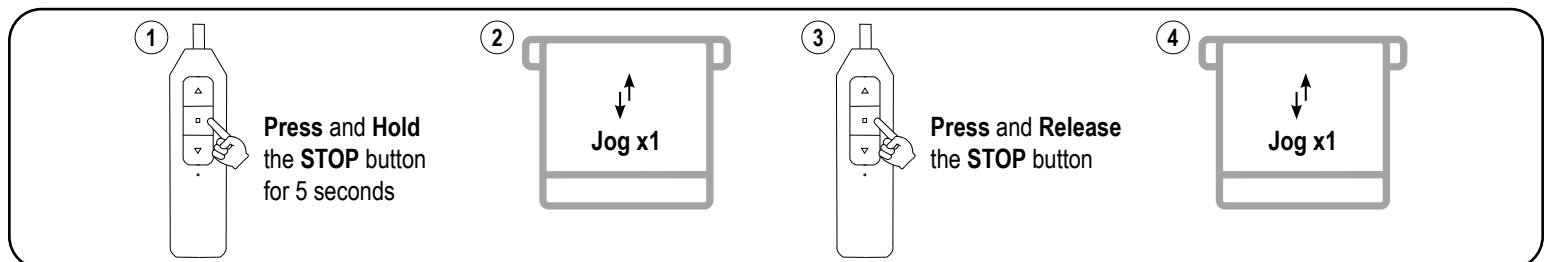

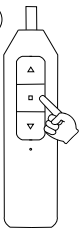
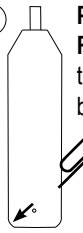
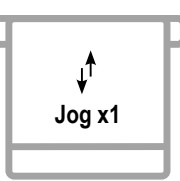
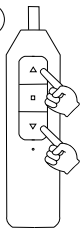
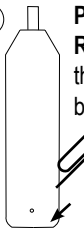
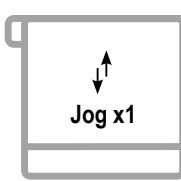

# QUICK PROGRAMMING GUIDE

## Adjust the Top and/or Bottom Limit

-  Move the shade to the limit that should be adjusted
-  Press and Release the **PROG** button
-  Jog x1
-  Adjust the shade to the desired limit position
-  Press and Release the **PROG** button
-  Jog x1

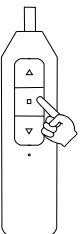
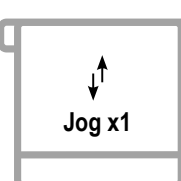
## Factory Motor Reset

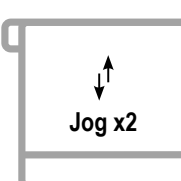

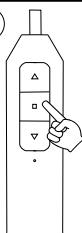
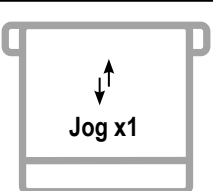
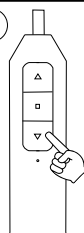
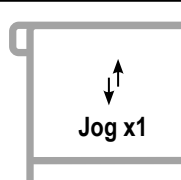

-  Press and Hold the **STOP** button for 5 seconds
-  Jog x1
-  Press and Hold the **PROG** button for 7 seconds
-  Jog x2

**IMPORTANT:** All limits will be erased. The motor direction will return to default and may need to be adjusted.

## Reverse UP and DOWN Commands (Only if necessary)

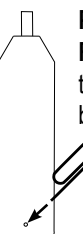
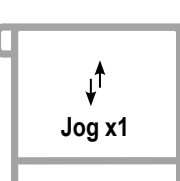
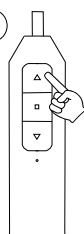
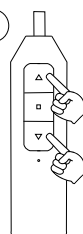
-  Press and Hold the **STOP** button for 5 seconds
-  Jog x1
-  Press and Release the **DOWN** button
-  Jog x1

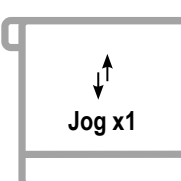
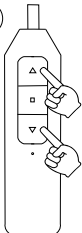
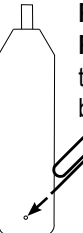
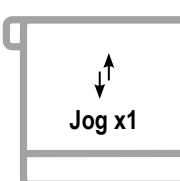
## Set Upper and Lower Limits ( Only after Factory Motor Reset)

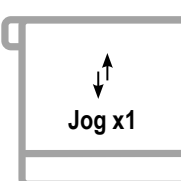
-  Press and Release the **PROG** button
-  Jog x1
-  Press **UP** to set the **TOP LIMIT**
-  Adjust the shade to the desired top limit
-  Press and Release the **PROG** button
-  Jog x1
-  Adjust the shade to the desired lower limit
-  Press and Release the **PROG** button
-  Jog x1
-  Press and Release the **PROG** button
-  Jog x1

6. Charge the Battery

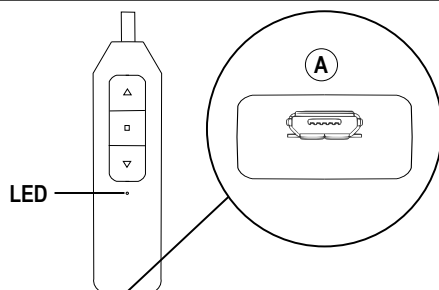

When the shade begins to operate slower than normal or only beeps when you attempt to operate, it is time to charge the battery.

To Charge, connect a standard micro USB cable into the bottom of the wand (A) and into USB 5V/2A (max) power supply. A red LED on the wand indicates that the battery is charging. To fully charge the batteries, allow the batteries to charge for at least 1 hour after the LED on the wand turns green.

**Note:** A typical charge cycle can take between 4-6 hours.

Troubleshooting

Issues	Possible Causes	Solution
The shade is not responding	Built in battery is depleted	Recharge with compatible USB 5V/2A (max) adapter and a micro USB cable. Details under "6. Charge the Battery"
	Wand is not fully connected to the motor	Check the connection between the wand and the motor
The shade moves the opposite direction on the control buttons	The motor direction is reversed	See details under "Reverse Up and Down Commands"
The shade stops by itself before it reaches the top or bottom limit	A favorite position was set	See details under "4. Remove a Favorite Position"
The shade only moves in small steps after pressing the button	The shade is operating on Window Shadings/ Dual Shades mode	Switch to Roller/Honeycomb mode by following the steps under "Switch between Roller and Window Shadings Mode"
	The shade has no limit set	See details under "Set Upper and Lower Limits"

Child Safety

**WARNING/ADVERTENCIA**  
5.1.3 Rev. 5/18 Print 5/18



Window Blind Cord Can **STRANGLE** Your Child. To prevent strangulation, purchase cordless products or products with inaccessible cords.  
 La cuerda de la persiana puede **ESTRANGULAR** a su niño. Para evitar el estrangulamiento, compre alternativas cuerda o productos con cuerdas inaccesibles.



1035121