

OPTIONS

Extension brackets and spacer blocks are used to mount a shade further away from the wall or window to clear thick window moldings, sills or handles.

SPACER BLOCKS

Each spacer block projects 1/2". Use a maximum of 3 blocks per installation bracket. The solid side of the blocks should face the wall. Secure with two long screws.



For Cellular and Angle Top Shades: Make sure the tops of the brackets are in alignment, parallel to the top of the window opening.
For Cellular Octagon, Hexagon and Trapezoid Shades: Make sure the tops of the brackets are perfectly horizontal and aligned at the same height.

EXTENSION BRACKETS

Each extension bracket projects up to 2-1/2". Secure extension bracket to the wall with two long screws. Use the nut and bolts to attach the mounting brackets to the extension bracket as shown.

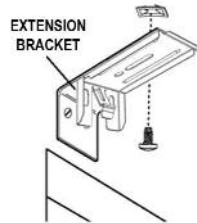

For Cellular Angle Top Shades: Make sure the tops of the brackets are in alignment, parallel to the top of the window opening.

For Cellular Octagon, Hexagon and Trapezoid Shades: Make sure the tops of the brackets are perfectly horizontal and aligned at the same height.

HOLD-DOWN BRACKETS

Hold-down brackets are used to keep the bottom of the shade from swaying when shade is mounted on a door or shade is exposed to the wind.



Lower shade and place the pins on the hold-down brackets into the bottom rail end caps. Mark where to drill the holes. Be sure bracket pins are aligned and level. Remove bracket from shade. Screw the brackets (one on each side) into the bottom of the window jamb or sill. Next, snap pin ends of bracket into holes in each end of bottom rail.

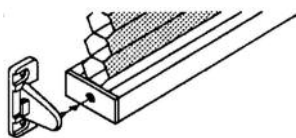

BOTTOM RAIL SHADE ADJUSTMENT:

- Lift bottomrail on the side to be adjusted. This will take the weight off the cord.
- Use a screwdriver or dime.
 - Turn screw clockwise to lift that side of the shade
 - Turn screw counter clockwise to lower that side of the shade
 - Half a revolution is 1/4" adjustment (maximum adjustment is 1/2")



CONGRATULATIONS ON YOUR SELECTION OF A CUSTOM PRODUCT

Because we take pride in the workmanship and quality that goes into every one of our products, we back our products with this LIFETIME LIMITED WARRANTY covering our Custom Made Blinds and Shades

We extend this lifetime limited warranty to the original purchaser. This warranty applies only to manually operated Custom Products properly installed in the window, door or interior area for which they were intended.

Installation of the product must be in accordance with accompanying instructions. The product cannot be modified. It is the purchaser's responsibility to maintain and clean the product in compliance with the instructions provided. The product must be used only in the window for which it was purchased.

Damage to the product resulting from misuse, abuse, direct exposure to salty air or discoloration due to sunlight or the passage of time is not covered by this warranty.

This warranty does not apply to conditions caused by normal wear and tear on the product.

THIS WARRANTY IS EXCLUSIVE AND IN LIEU OF ALL OTHER OBLIGATIONS, LIABILITIES OR WARRANTIES.

In no event shall we be liable for INCIDENTAL or CONSEQUENTIAL DAMAGES or for any other direct or indirect damage, loss, cost, expense or fee. Some states do not allow the exclusion or limitation of incidental or consequential damages, so this exclusion or limitation may not apply to you.

In the event of a defect under this warranty, we will repair or replace the product, at our option, provided it is returned to an authorized dealer.

Our warranty obligation excludes shipping charges and labor costs for measuring and installation. Repairs will be made with like or similar parts.

This warranty gives you specific legal rights, and you may also have other rights which vary from state to state.

Specialty Blinds and Shades are warranted for one year from the date of purchase. This warranty does not apply to Commercial Orders.

U.S. Pats. 4,450,027; 4,603,072; 4,631,108 and others.
Additional U.S. and Foreign Patents Pending.
51-01-324

CELLULAR SHADES

ANGLE CUTS

CELLULAR SHADES: ANGLED TOP, OCTAGON, HEXAGON, TRAPEZOID

- INSTALLATION INSTRUCTIONS
- PARTS IDENTIFICATION
- CARE INSTRUCTIONS
- LIFETIME LIMITED WARRANTY

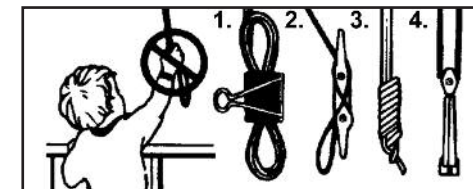

WARNING

To avoid possible strangulation, keep cords out of the reach of children. Use these devices:

1. Clamp or clothes pin
2. Cleat
3. Tie the cord to itself
4. Tie-down device

CARE INSTRUCTIONS

CELLULAR SHADES: Dust with a feather duster or vacuum frequently with a soft brush attachment. Fabric can be cleaned by gently blotting with a soft damp cloth or sponge.

CELLULAR SHADES ONLY: Shade may be immersed in lukewarm water with a mild detergent, for a more thorough cleaning.

BLACKOUT FABRICS: Do not immerse in water and avoid creasing during cleaning.

Please read instructions completely before starting!
Remember to treat your new shade with care when installing.

GET ACQUAINTED WITH YOUR NEW CELLULAR SHADE

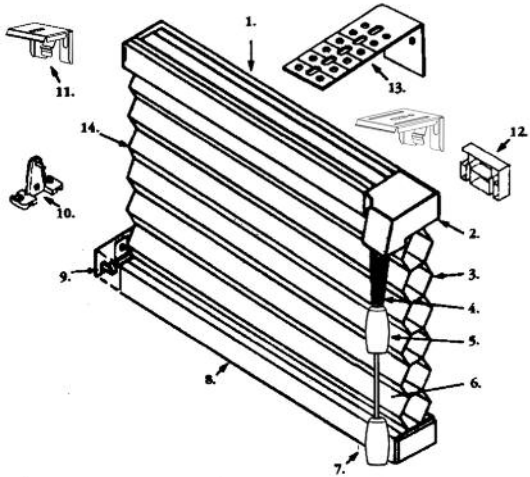

1. Color Coordinated Aluminum Headrail
2. Reliable Cordlock
3. Crisp 3/8" or 3/4" Pleats
4. Color Coordinated Multiple Cords
5. Plate Adjust
6. Single Color Coordinated Cord
7. Tassel
8. Color Coordinated Aluminum Bottomrail
9. Color Coordinated End Cap
10. Hold Down Bracket
11. Installation Bracket
12. 1/2" Spacer Block
13. 3" Extension Bracket
14. No Visible Cords or Cord Holes

HOW TO INSTALL

1. TOOLS

- Metal measuring tape - not cloth
- Power drill and bits
- Long flat blade screwdriver
- Phillips head screwdriver
- Scissors

2. INSTALLATION BRACKETS

The brackets provided are used for all types of installations - outside, ceiling and inside. Note: Two screws are supplied for each bracket. These are screws with slotted hex heads, suitable for wood or sheet metal mounting surfaces. FOR PLASTER, DRYWALL, CONCRETE, STONE, BRICK OR TILE installations, we recommend using plugs or anchors.



BRACKET SPACING: Position the first two brackets 2-1/4" from the end of the shade.

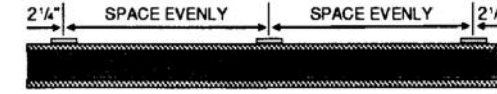

If more than two brackets are needed

(see Chart at right), space them evenly between the two end brackets.

Shade Width	Number of Brackets
Up to 31'	2
31 1/8" to 60"	3
60 1/8" to 84"	4

Note for Cellular and Angle Top Shades: If the rails are the same length, align the bottom brackets directly under the top brackets. If the rail lengths are different, measure the bracket spacing separately for each rail.

Note for Cellular Octagon, Hexagon and Trapezoid Shades: Spring-anchored shades require brackets at the bottom of the window opening, as well as at the top. Align the bottom brackets directly under the top brackets.

INSIDE MOUNT

STEP 1 – BRACKETS

With mounting brackets level and flush with the window frame, screw through the top of the bracket. All brackets' front edges should be aligned.

For Cellular 3/8" pleat shades, a 1-1/2" window depth is required for a flush mount.
For Cellular 3/4" pleat shades, a 2-1/4" window depth is required for a flush mount.

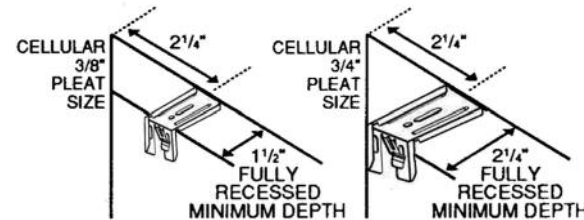

STEP 2 – INSTALLING SHADE

Unwind cord and let it hang. Insert the top front of the headrail into the front lip of the brackets. Push on the rail until it snaps into place. Make sure that no material is caught between the headrail and the installation brackets.

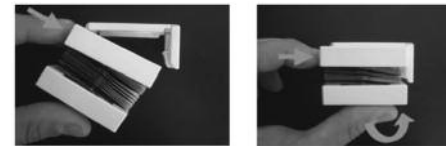

OUTSIDE MOUNT

STEP 1 – BRACKETS

With the shade open, hold it up to the wall or ceiling in the position you want it to hang. Make sure the shade is centered and level. Mark wall 2-1/4" past end of the headrail. Remove shade and place mounting brackets level with pencil marks. Secure with two screws for each bracket. For Cellular 3/8" pleat shades, a minimum 5/8" flat surface is needed. For Cellular 3/4" pleat shades, a minimum 1" is needed.

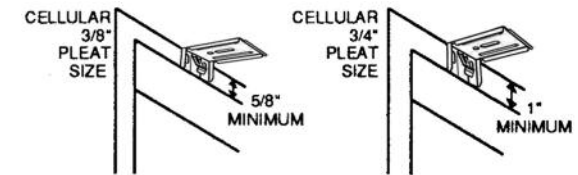

STEP 2 – INSTALLING SHADE

Unwind cord and let it hang. Insert the top front of the headrail into the front lip of the brackets. Push on the rail until it snaps into place. Make sure that no material is caught between the headrail and installation brackets.



OPERATION

Keep the cord close to the fabric when operating the shade, no more than 15° from vertical (see diagram at right).

To raise the shade: pull the cord toward the center of the shade (approximately 30° from vertical) until lock is released. Continue pulling cord at this angle until shade reaches desired position. To lock, move the cord back to the edge of the shade.

To lower the shade: pull the cord toward the center of the shade (approximately 30° from vertical) until lock is released. Let cord slip slowly through fingers until shade reaches desired position. To lock, move the cord back to the edge of the shade.

Note: Cellular and Angle Top Shades will raise to the lowest side of the headrail. Cellular Octagon and Hexagon Shades will raise to the widest portion of the shade.

