

INSTALLING QUARTER CIRCLE & ARCH SHADES (CONT'D)

INSTALLATION OF ARCH SUPPORT HOOKS (USED ONLY WITH HEAVY SHADES)

Arch support hooks are used instead of arch support clips on inside mounted applications where additional support and/or reduction of the light gap is needed. The hooks lift the outer edge of the fabric toward the window frame.

The number of arch support hooks needed for a particular installation varies according to the width of the arch at the base (see chart). The procedure for spacing the hooks depends upon whether an odd or even number is used.

Shade Width	Number of Hooks
Up to 17"	1
17 1/8" to 28"	2
28 1/8" to 40"	3
40 1/8" to 51"	4
51 1/8" to 62"	5
62 1/8" to 74"	6
74 1/8" to 84"	7

For an odd number of hooks: Position the first hook at the top center of the opening, at the 90° point. Position the next two hooks at the 45° points of the arch. The 45° points can be found by using a protractor, or by multiplying the base width by 0.4 and measuring that distance up from the two corners. Any additional hooks required should be spaced evenly between the first three hooks. No hooks should be positioned lower than the 45° points.

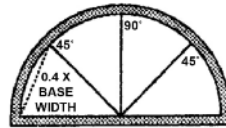

For an even number of hooks: Position the first two hooks at the 45° points and then space any additional hooks evenly between them. If a support cord is used with an even number of hooks, install a separate screw above the center cell to hold the cord.

Note: With elliptical arches, the hooks may need to be spread wider apart than they are with perfect arches. Place the hooks based upon the support needs of the specific arch shape.

Attach each arch support hook using the Phillips screw provided. Be sure to mount the hooks at a consistent depth within the sill, as shown. To find the correct depth, install the shade into the mounting brackets and mark on the sill where the exact center of a fabric cell is located when the arch is perfectly upright. The point of the hook should be located at that depth. Remove the shade from the window opening.

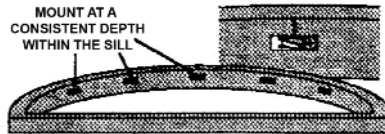

After mounting the arch support hooks, re-install the shade. Then, while supporting the fabric, carefully use the pointed end of the hooks to puncture the fabric between the glue lines, at least 1/8" into the cell. Continue to support the fabric until all hooks are engaged. Once the hooks are attached to the fabric, they can be bent or reconfigured to shape the arch to the best possible appearance. **Caution:** The tips of the arch support hooks are very sharp; use care when attaching the fabric to avoid puncturing or injuring a finger.

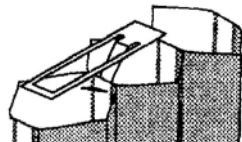

CONGRATULATIONS ON YOUR SELECTION OF A CUSTOM PRODUCT

Because we take pride in the workmanship and quality that goes into every one of our products, we back our products with this **LIFETIME LIMITED WARRANTY** covering our Custom Made Blinds and Shades

We extend this lifetime limited warranty to the original purchaser. This warranty applies only to manually operated Custom Products properly installed in the window, door or interior area for which they were intended.

Installation of the product must be in accordance with accompanying instructions. The product cannot be modified. It is the purchaser's responsibility to maintain and clean the product in compliance with the instructions provided. The product must be used only in the window for which it was purchased.

Damage to the product resulting from misuse, abuse, direct exposure to salty air or discoloration due to sunlight or the passage of time is not covered by this warranty.

This warranty does not apply to conditions caused by normal wear and tear on the product.

THIS WARRANTY IS EXCLUSIVE AND IN LIEU OF ALL OTHER OBLIGATIONS, LIABILITIES OR WARRANTIES.

In no event shall we be liable for INCIDENTAL or CONSEQUENTIAL DAMAGES or for any other direct or indirect damage, loss, cost, expense or fee. Some states do not allow the exclusion or limitation of incidental or consequential damages, so this exclusion or limitation may not apply to you.

In the event of a defect under this warranty, we will repair or replace the product, at our option, provided it is returned to an authorized dealer.

Our warranty obligation excludes shipping charges and labor costs for measuring and installation. Repairs will be made with like or similar parts.

This warranty gives you specific legal rights, and you may also have other rights which vary from state to state.

Specialty Blinds and Shades are warranted for one year from the date of purchase. This warranty does not apply to Commercial Orders.

U.S. Pats. 4,450,027; 4,603,072; 4,631,108 and others.
Additional U.S. and Foreign Patents Pending.
51-01-324

CELLULAR SHADES

ARCH, QUARTER CIRCLE, CIRCLE

- INSTALLATION INSTRUCTIONS
- PARTS IDENTIFICATION
- CARE INSTRUCTIONS
- LIFETIME LIMITED WARRANTY

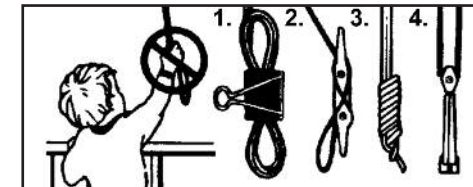

WARNING

To avoid possible strangulation, keep cords out of the reach of children.

CARE INSTRUCTIONS

CELLULAR SHADES: Dust with a feather duster or vacuum frequently with a soft brush attachment. Fabric can be cleaned by gently blotting with a soft damp cloth or sponge.

CELLULAR SHADES ONLY: Shade may be immersed in lukewarm water with a mild detergent, for a more thorough cleaning.

BLACKOUT FABRICS: Do not immerse in water and avoid creasing during cleaning. Spunlace material cannot be immersed.

HOW TO INSTALL

1. TOOLS

- Metal measuring tape – not cloth
- Power drill and bits
- Long flat blade screwdriver
- Phillips head screwdriver
- Scissors

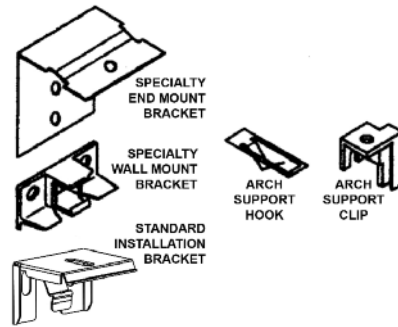

2. INSTALLATION BRACKETS

There are 5 types of mounting brackets, depending on your installation needs.

INSTALLING FULL CIRCLE SHADES

STEP 1 – FROM THE CIRCLE

Remove the backing from the double-sided tape and join the top and bottom pleats together. Be careful to align the holes on each side and to pull the cords taut at the top of the shade. Tie the cords together to further prevent the shade from opening and cut off any excess cord (see drawing at left).

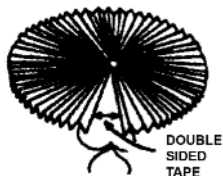

STEP 2 – INSTALL THE CLIPS

FOR INSIDE MOUNTS:

The window well should be at least 1" deep. Position the support clips so that the clip fingers are 3/4" inside the window well. Attach four support clips – one at the top and bottom and one on each side. Place the clips at the widest horizontal and tallest vertical points. Evenly space additional clips as needed for support (see drawing at right).

Remove the backing from the double-sided tape and join the top and bottom pleats together. Be careful to align the holes on each side and to pull the cords taut at the top of the shade. Tie the cords together to further prevent the shade from opening and cut off any excess cord (see drawing at left).

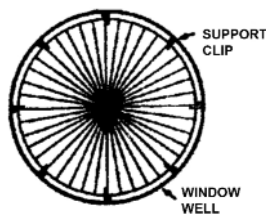

FOR OUTSIDE MOUNTS:

A flat surface around the window opening at least 5/8" wide is required. Position the outer edge of the clips where you want the outer edge of the circle to be. Attach four support clips – one at the top and bottom and one on each side. Place the clips at the widest horizontal and tallest vertical points. Evenly space additional clips as needed for support.

FOR BOTH INSIDE AND OUTSIDE MOUNTS:

Place the shade in the window opening and insert the pleats between the clip fingers. Count the number of pleats in the shade so that the support clips divide the shade into four equal sections. With your finger, feel through the fabric around to the back of the clip. Locate the top portion of the "T" finger and bend it up to pinch the fabric in place (see drawing at left).

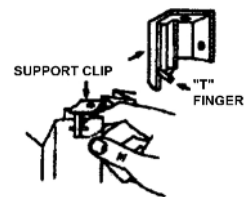

INSTALLING QUARTER CIRCLE & ARCH SHADES



QUARTER CIRCLE



ARCH
Stationary, Movable
and Elliptical

STEP 1 – INTRODUCTION QUARTER CIRCLE SHADES

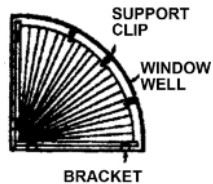

Quarter Circle shades use two rails, with the vertical rail butting against the top of the horizontal rail (see drawing at left).

ARCH SHADES – STATIONARY & ELLIPTICAL

Install fabric onto the rail. Your Arch shade will arrive with the bottom pleat of the fabric stack inserted in the rail and an aluminum slat taped to the top pleat. First, carefully pull off one end cap. Then fan out the fabric and slide the top pleat into the rail (see drawing at right). Center the arch and replace the end cap onto the end of the rail.

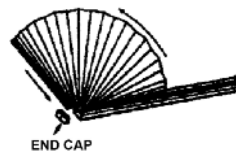

ARCH SHADES – MOVABLE USING STANDARD INSTALLATION BRACKETS

A movable arch uses two rails. They will butt together in the center when the shade is fully open.

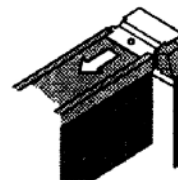

STEP 2 – INSTALL BRACKETS

INSIDE MOUNT INSTALLATIONS USING SPECIALTY END MOUNT BRACKETS

Insert the brackets into the small grooves on the rail. With an arch over a standard shade, pull the cordlock out about 1/2" and slide the arch down to fit the bracket into the grooves. Push the bracket and cordlock into the rail, as shown, and re-center the arch. On the other end of the rail, install the bracket over the end cap.

When specialty end mount brackets are used with a stand-alone arch, the bracket ends point up toward the top of the arch, instead of down.

To fully recess the arch, the window opening must be at least 1-1/4" deep for Cellular 3/8" pleat size and 1-7/8" deep for Cellular 3/4" pleat size.

Hold the shade assembly in the window opening and mark where to drill holes for the mounting bracket screws. Use a level to make sure the rail is perfectly horizontal. After marking and drilling the mounting screw holes, again position the shade assembly in the window opening. Gently pull the fabric forward to install the mounting screws. Be very careful not to damage or wrinkle the fabric during the installation process.

INSTALLING QUARTER CIRCLE & ARCH SHADES (CONT'D)

OUTSIDE MOUNT INSTALLATIONS USING SPECIALTY WALL MOUNT BRACKETS

Attach the brackets to the mounting surface. You will need a flat surface at least 1-3/4" wide by 7/8" high for each bracket. Position two specialty wall mount brackets so that their outside edges will be 1-1/2" in from the ends of the shade. If a third bracket is required (see chart), center it between the two end brackets.

Shade Width	Number of Brackets
Up to 31"	2
31 1/8" to 60"	3
60 1/8" to 84"	4

To install an arch over a standard shade into the specialty wall mount bracket, tilt the arch away from you and slip the top edge of the rail into the top lip of the bracket. Push the rail down and in to lock it into the lower lip of the bracket, as shown. For stand-alone arches, mount the bracket upside-down and change the installation accordingly.

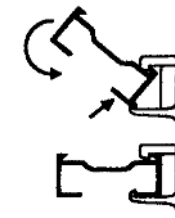

STAND-ALONE INSTALLATIONS USING STANDARD INSTALLATION BRACKETS

With inside mounted applications, the flat surface of the sill must be at least 1" deep to attach the installation brackets. To fully recess the shade, the flat surface must be at least 1-1/2" deep for Cellular 3/8" pleat size and 2-1/4" deep for Cellular 3/4" pleat size. With outside mounts, bracket attachment requires a flat vertical surface at least 5/8" high for Cellular 3/8" pleat size and at least 1" high for Cellular 3/4" pleat size.

Bracket spacing is the same for both inside and outside mounts. Position two installation brackets on the mounting surface so that their centerlines will be 2-1/4" in from the ends of the shade. If a third bracket is required (see chart above right), center it between the two end brackets.



To mount the shade, push the rail into the installation brackets. The front lip on the brackets fits into the front groove on the bottom of the rail. Push on the rail until it snaps into place. Then, after making sure that no fabric is caught between the tab and the rail, tighten the tab screw on each bracket until it is just snug. Do not over tighten. To access the tab screw, gently move the fabric forward if necessary.

STEP 3 – INSTALL SUPPORT CLIPS

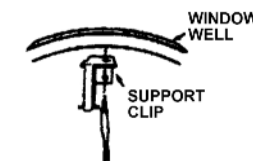

Mount a support clip at the top of the window well (see drawing at left). If necessary, space additional clips evenly along the arch no more than 18" apart. Turn the clips so that the pleats fit neatly between the fingers of the clip.

With your finger, feel through the fabric around to the back of the clip. Locate the top portion of the "T" finger and bend it up to pinch the fabric in place (see drawing at right). Continue with each clip until complete.

