

Cellular Shades

Installation, Operation and Care
Instructions

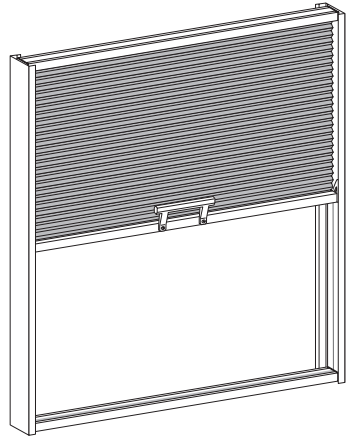
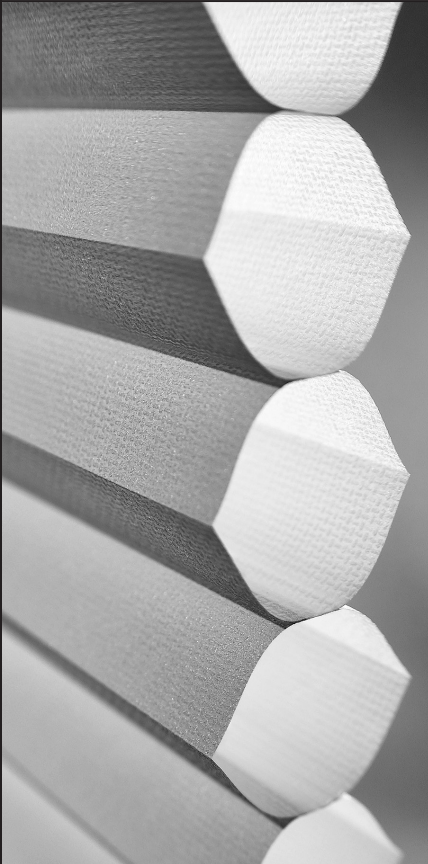

Skylight Application

CONTENTS

Getting Started:

| | |
|----------------------------------|---|
| Product View | 1 |
| Tools and Fasteners Needed | 2 |

Installation:

| | |
|---|----|
| Installation Overview | 3 |
| Mount the Installation Brackets — Inside Mount | 4 |
| Mount the Installation Brackets — Outside Mount | 5 |
| Install the Shade | 7 |
| Mount the Side Tracks | 7 |
| Install the Anchor Rail | 8 |
| Adjust the Shade | 9 |
| Install the Fabric Strip | 10 |
| Attach the Handle | 10 |

Operation:

| | |
|-------------------------|----|
| Operate the Shade | 10 |
| Troubleshooting | 11 |

Care:

| | |
|---|----|
| Removing the Shade (If Necessary) | 12 |
| Cleaning Procedures | 13 |

| | |
|------------------------------|-----------|
| Warranty Policy | 14 |
|------------------------------|-----------|

Product View

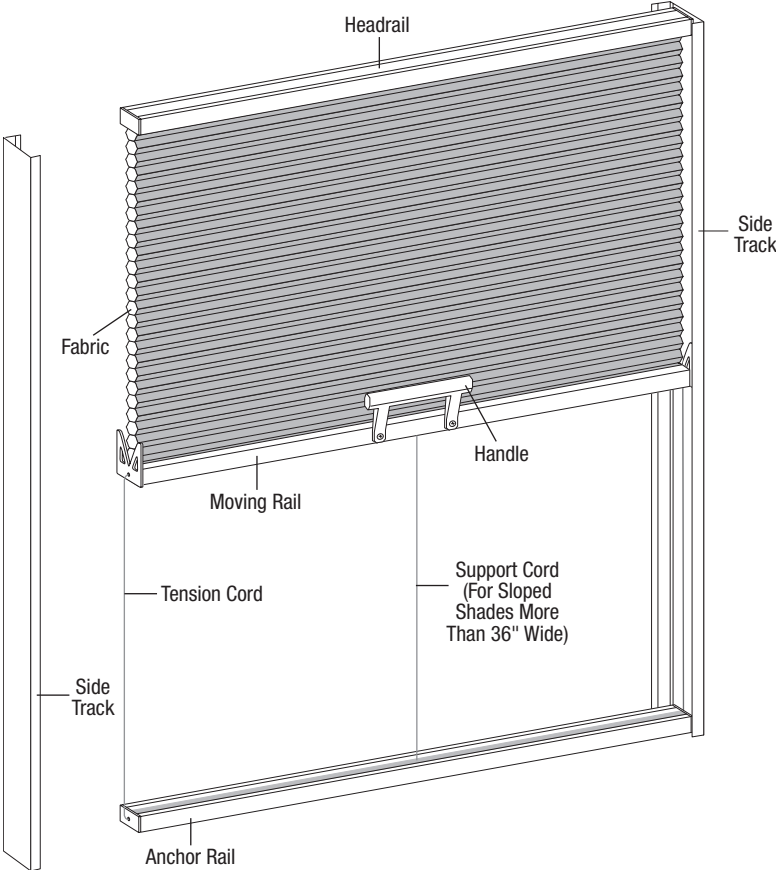

GETTING STARTED

Thank you for purchasing cellular shades. With proper installation, operation, and care, your new shades will provide years of beauty and performance. Please thoroughly review this instruction booklet before beginning the installation.

Tools and Fasteners Needed

- Flat blade and Phillips screwdriver
- Level (laser level is recommended)
- Measuring tape and pencil
- Pliers
- Power drill, $\frac{3}{32}$ " drill bit, and $\frac{1}{4}$ " hex driver

In addition, you will need fasteners designed to work with the specific mounting surface(s).

- **#6 Hex Head Screws (Provided).** Two $1\frac{1}{2}$ " screws are provided per installation bracket.
- **#6 Longer Hex Head Screws (Not Provided).** If using spacer blocks, use #6 screws long enough for a secure attachment. Add $\frac{1}{2}$ " length for each spacer block.
- **Speed Nuts and Screws (Provided).** Extension brackets come with speed nuts and screws.
- **Drywall Anchors (Not Provided).** Use drywall anchors when mounting into drywall.



#6 x $1\frac{1}{2}$ "
Hex Head Screw
(Provided)



Longer #6 Hex Head Screw
for Use with Spacer Blocks
(Not Provided)



Speed Nut
and Screw
(Provided with Each
Extension Bracket)

Installation Overview

■ Your order will include the correct number of installation brackets for your shade width, as shown in the table below.

- Outside mounts require installation brackets for both the headrail and anchor rail.
- Inside mounts require installation brackets for the headrail only. The anchor rail is screwed directly to the casement.

| | Shade Width | Brackets Required |
|----------------------|--------------------|--------------------------|
| Inside Mount | 18" – 31" | 2 |
| | 31 1/8" – 60" | 3 |
| Outside Mount | 18" – 31" | 4 |
| | 31 1/8" – 60" | 6 |

3/8" Installation Bracket

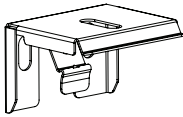

3/4" Installation Bracket

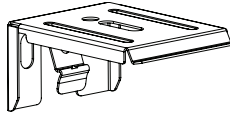

Mounting Types and Window Terminology

If the installation brackets are mounted correctly, the rest of the installation process follows very easily. To prepare for this important first step, review the mounting types and basic window terminology illustrated below.

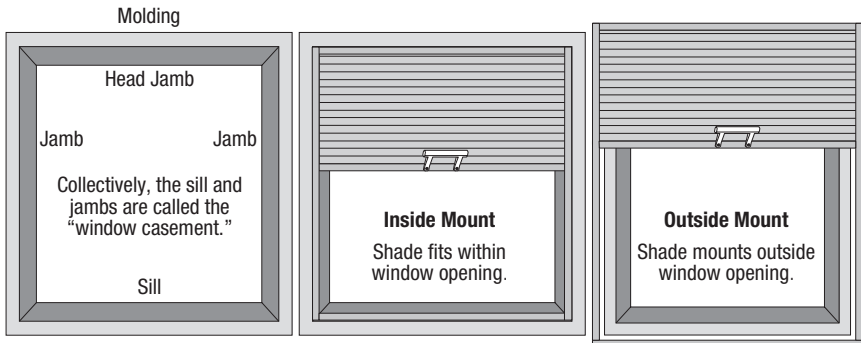

■ Refer to the appropriate page below based on your order:

- **Inside Mount — Page 4**
- **Outside Mount — Page 5**

INSTALLATION

Mount the Installation Brackets — Inside Mount

- Mark $4\frac{1}{2}$ " from each jamb for the headrail.
 - If more than two brackets are required, center the third bracket.
 - If your shade has a support cord, position the third bracket 1" to the left of center.

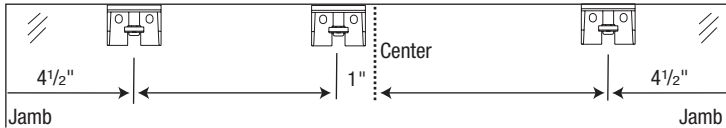

- Center the brackets on your marks and mark the location of the screw holes.
 - Mounting depth will vary depending on the fabric pleat size. Refer to the chart for depth requirements.
 - For fully recessed mounting, the entire shade is inside the window casement.

IMPORTANT: The front edges of the installation brackets must be level and aligned.

| Bracket Type | Minimum | Fully Recessed |
|---------------------------|------------------|--------------------|
| $\frac{3}{8}$ " Standard | 1" | $1\frac{11}{16}$ " |
| $\frac{3}{4}$ " Standard* | $1\frac{1}{4}$ " | $2\frac{1}{2}$ " |

*Double and triple cell fabrics use $\frac{3}{4}$ " brackets.

- Drill the screw holes using a $\frac{3}{32}$ " drill bit.

IMPORTANT: Use drywall anchors when mounting into drywall.

- Attach the installation brackets using the screws provided.
 - Check that the mounting surface is level and the brackets are aligned. If mounting to a heavily textured surface, shim the brackets, if needed.

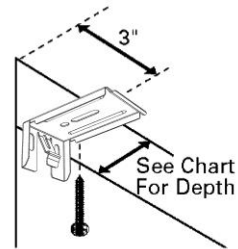

Proceed to "Install the Shade" on page 7.

Mount the Installation Brackets — Outside Mount

- Center the headrail and the anchor rail over the window opening at the desired height. Use a pencil to lightly mark each end of the headrail and the anchor rail.
 - Alternatively, measure the width of the headrail and the anchor rail and use that width to mark the headrail and the anchor rail end points over the window opening.
- Mark 4½" from each end of the headrail and the anchor rail.
 - If more than two brackets are required, center the third bracket.
 - If your shade has a support cord, position the third bracket 1" to the left of center.

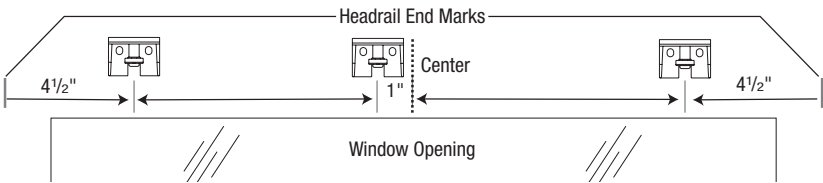

- Center the brackets on your marks, then mark each of the screw holes.
 - A minimum flat vertical surface of 5/8" for a 3/8" bracket or 1" for a 3/4" bracket is required to mount the brackets.
 - The top of the installation brackets or extension brackets should be at the desired top point of the shade.

IMPORTANT: The brackets must be level and aligned to each other.

CAUTION: The rear of the brackets must be flush against a flat mounting surface. *Do not mount brackets on curved molding.*

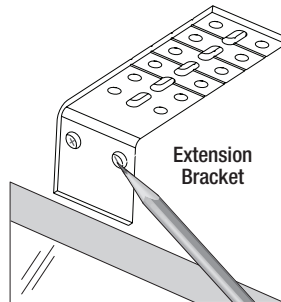
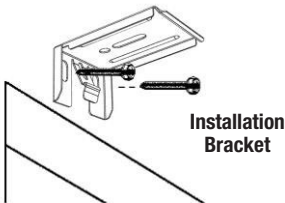

INSTALLATION

- Drill the screw holes using a $\frac{3}{32}$ " drill bit.

IMPORTANT: Use drywall anchors when mounting into drywall.

- Attach the installation brackets using the screws provided.

IMPORTANT: The front edges of the installation brackets must be level and aligned to each other.

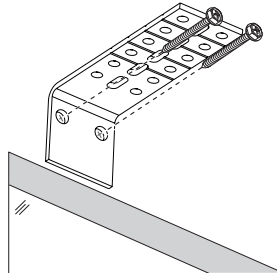
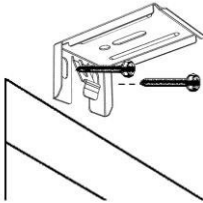

- If using spacer blocks with installation brackets, attach the spacer block(s) and installation bracket to a flat vertical mounting surface with #6 mounting screws long enough for a secure installation.

CAUTION: The rear spacer block must be flush against a flat mounting surface. *Do not mount spacer blocks and installation brackets on curved molding.*

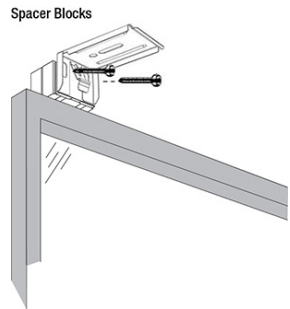

- Each spacer block projects the installation bracket $\frac{1}{2}$ " from the mounting surface.
A maximum of $1\frac{1}{2}$ " of spacer blocks per installation bracket is recommended.
- The solid side of the spacer blocks faces the mounting surface.

- If using extension brackets, attach an installation bracket to the underside of each extension bracket using the provided screws and speed nuts.

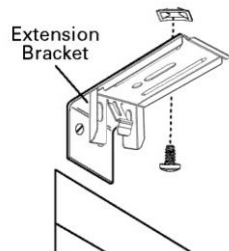

Proceed to "Install the Shade" on page 7.

Install the Shade

Standard Brackets

- Position the shade so that the front (colored) side of the fabric faces you.
- Slip the headrail into the installation brackets so the front of the bracket slides under the front groove on the top of the headrail.
- Gently roll the back of the headrail up and push back to snap into place.

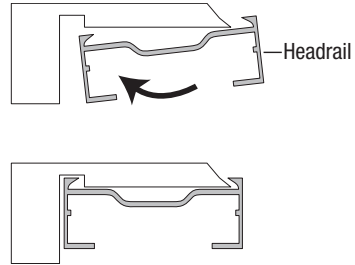

IMPORTANT: Do not remove the rubber bands that hold the headrail, fabric, moving rail, and anchor rail until after the side tracks are mounted.

Mount the Side Tracks

Inside Mount

- Attach the side tracks to the inside of the window using the pre-drilled holes on alternate sides of the track center line.
 - For sloped installations, align the wide flange with the front edge of the window opening.
 - For vertical installations, align the narrow flange flush with the edge of the opening.
- Make sure the rails are centered within the side tracks.

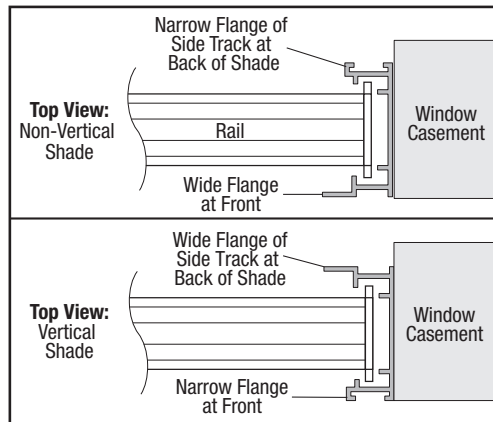

- Make sure the side tracks are parallel by measuring the distance between them at the top and bottom of the window.
- If the side tracks are more than 1/4" off of parallel, use shims under the mounting screw locations, starting at the ends of the side tracks.

INSTALLATION

Outside Mount

The narrow flange on the side tracks should be at the front of the shade. Holes are drilled in the groove near the edge of the wide flange.

- Attach the wide flange to the outside of the window casement using the appropriate fasteners.
- Make sure the rails are centered within the side tracks.
- Make sure the side tracks are parallel by measuring the distance between them at the top and bottom of the window.

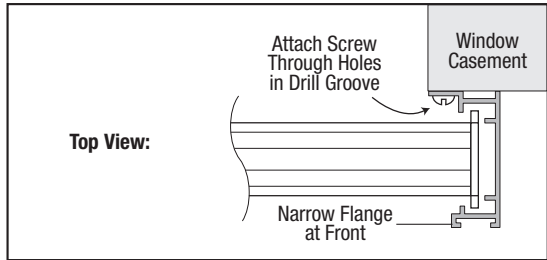

Install the Anchor Rail

- Cut the rubber bands that are holding the rails and fabric together.
- Lower the anchor rail to the bottom of the side tracks.
- Make sure the open side of the anchor rail faces up, with the spring and cords exposed.
 - If the open side is covered by a fabric strip, remove it. The fabric strip will be re-installed after making any necessary shade adjustments.

NOTE: Remove one end cap before sliding the fabric strip out of the anchor rail.

- **Outside mounts:** Snap the anchor rail into the installation brackets.
 - **Inside mounts:** Attach the anchor rail directly to the sill by using the additional 2 screws provided.
- NOTE:** The screw holes are pre-drilled in the anchor rail.
- Center the rail within the side tracks before mounting.

Anchor Rail Outside Mount

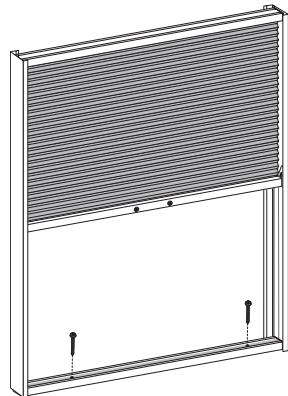
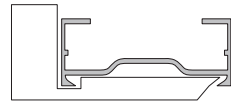
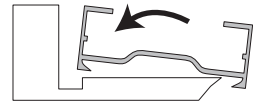

Adjust the Shade

Tension Cords

The moving rail should slide easily, yet hold in position when it is released. Adjust the tension cords in the anchor rail if the moving rail does not slide properly.

- Move the slip knot to the right to increase the cord tension. Do not stretch the spring to a length greater than 5½".
- Move the slip knot to the left to decrease the cord tension.

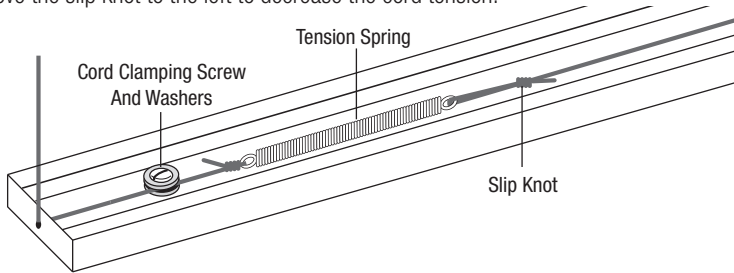

Moving Rail

The moving rail should be parallel to the anchor so that the two rails make even contact when the shade is closed. Adjust the moving rail if it is not parallel.

- Loosen the cord clamping screw.
- Slide the cord between the two washers.

CAUTION: Do not adjust the cord tension while you make this adjustment.

Support Cord Tension (If Applicable)

If your shade has a support cord, it should be very taut. To adjust:

- Loosen the support cord clamping screw.
- Pull the cord through the two washers to the desired tension.
- Tighten the screw.
- Make sure the cord is held taut between the washers.

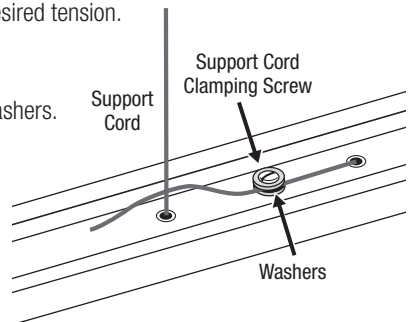

INSTALLATION/OPERATION

Install the Fabric Strip

- Center the fabric strip on the anchor rail.
- Angle the fabric strip and insert into the back channel of the anchor rail.
- Gently bow the fabric strip and insert the other edge into the front channel of the anchor rail.

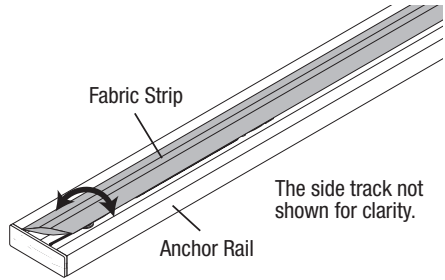

Attach the Handle

- Arrange the handle with the bar toward the fabric.
- Align the holes on the handle with the holes in the moving rail.
- Use a Phillips screwdriver to attach the handle.

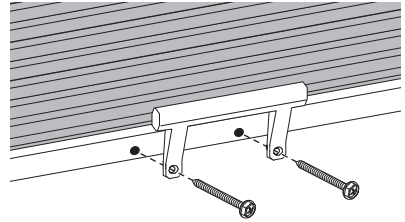

CAUTION: To prevent damage to the shade do not overtighten the screws.

Operate the Shade

To Raise the Shade

- Slowly and steadily push up on the moving rail handle. Allow the shade to stack evenly.

To Lower the Shade

- Slowly and steadily pull down on the moving rail handle.

Extension Pole

- Place the hook on the extension pole around the moving rail handle.
- Slowly and steadily push up or pull down on the moving rail handle to raise or lower.

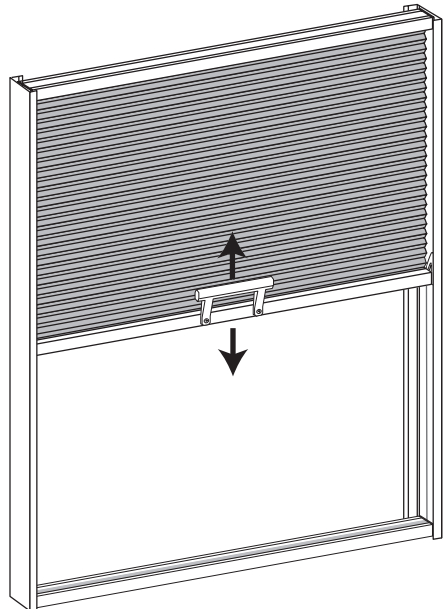

Troubleshooting

| | |
|-----------------|--|
| Problem | The shade will not fit into the installation brackets. |
| Solution | <p>Check that the installation brackets are level and aligned. Shim the installation brackets to level the headrail, if necessary.</p> <p>Be sure the heads of the screws are flush against the installation bracket.</p> <p>Check that the headrail is completely inserted into the installation brackets. See “Install the Shade” on page 7.</p> |
| Problem | The shade is hard to raise or lower, or will not raise or lower. |
| Solution | <p>Make sure that the shade fabric is not caught between the installation bracket and the headrail.</p> <p>Check that the headrail and installation brackets are level and aligned in the window. Shim the installation brackets to level the headrail, if necessary.</p> |
| Problem | The shade raises or lowers unevenly or the bottom rail is uneven when fully raised. |
| Solution | <p>Check that the headrail and installation brackets are level and aligned. Shim the installation brackets to level the headrail, if necessary.</p> <p>Check to see if there is an obstruction in the shade’s path. If a shade hits an obstruction as it is lowered it may become misaligned. This may cause the shade to be angled or tilted when fully raised. Try lowering the shade completely, then raising it to allow it to self-correct.</p> <p>Adjust the cord tension. See “Adjust the Shade” on page 9.</p> |

Removing the Shade (If Necessary)

- Fully raise the shade.
- While holding the headrail, loosen the space between bracket and headrail with a flathead screwdriver on each bracket to release the headrail.
- **Outside mounts:** Loosen the space between bracket and headrail with a flathead screwdriver on each bracket to release the anchor rail.
- **inside mounts:** Loosen the screws in the anchor rail.

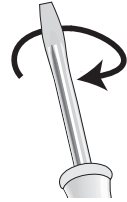
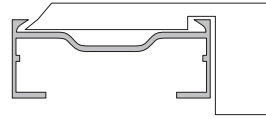

Cleaning Instructions

Honeycomb shades are made of an anti-static, dust resistant fabric which repels dirt and dust. For most of these fabrics, the following options are available if your shade needs cleaning

DUSTING: Regular light dusting with a feather duster is all the cleaning that is needed in most circumstances.

VACUUMING: Use a hand-held vacuum with low suction for more thorough dust removal.

SPOT CLEANING: Use the following steps for spot cleaning: (1) Prepare a solution of warm water and mild dishwashing detergent. (2) Dampen a clean cloth in the solution and ring it out. (3) Dab the spot with the dampened cloth until it is gone. **DO NOT RUB THE FABRIC.** (4) Allow the shade to dry in the completely lowered position.

CAUTION: Avoid creasing Blackout fabrics during cleaning.

DEEP CLEANING: Use the following steps for deep cleaning: (1) Immerse shade in basin or bathtub filled with warm water and mild detergent. (2) Rinse with clean water. (3) Fully raise shade and tilt to eliminate excess water, (4) Reinstall damp shade, lower it, and let it dry completely.

CAUTION: Do not immerse Blackout fabrics. Do not immerse headrail.

ULTRASONIC CLEANING: Standard shades, except those made with Blackout Lining can be ultrasonically cleaned by a professional.

- Specify that a mild detergent be used.
- Never immerse the headrail in the solution.
- Dry the shade completely in the lowered position.

CAUTION: Do not ultrasonically clean Blackout fabrics. Do not immerse headrail.

WARRANTY INFORMATION

Lifetime Limited Warranty covering our Custom Made Shades

We extend this lifetime limited warranty to the original purchaser. This warranty applies only to manually operated Custom Products properly installed in the window, door or interior area for which they were intended. Installation of the product must be in accordance with accompanying instructions. The product cannot be modified. It is the purchaser's responsibility to maintain and clean the product in compliance with the instruction provided. The product must be used only in the window for which it was purchased. Damage to the product resulting from misuse, abuse, direct exposure to salty air or discoloration due to sunlight or the passage of time is not covered by this warranty.

This warranty does not apply to conditions caused by normal wear and tear upon the product. This warranty is exclusive and in lieu of all other obligations, liabilities or warranties. In no event shall the Manufacturer be liable for incidental or consequential damages or for any other direct or indirect damage, loss, cost, expense or fee. Some states do not allow the exclusion or limitation of incidental or consequential damages, so this exclusion or limitation may not apply to you.

In the event of a defect under this warranty, we will repair or replace the product, at our option, provided it is returned to our store. Our warranty obligation excludes shipping charges and labor costs for measuring and installation. Repairs will be made with like or similar parts. This warranty gives you specific legal rights, and you may have other rights which vary from state to state.

Notes: Motorization Systems are warranted for five years from the date of purchase. Specialty Blinds and Shades are warranted for one year from the date of purchase.

This warranty does not apply to Commercial Orders.